

Single phase flow characteristics in rectangular microchannel: entrance length and friction factor

Ines Hamidi and Abdelmottaleb Ouederni

Department of Chemical Engineering, Research Laboratory: Process Engineering and Industrial Systems,
National Engineering School of Gabes (ENIG), 6029 Zrig, University of Gabes, Tunisia

Copyright © 2014 ISSR Journals. This is an open access article distributed under the **Creative Commons Attribution License**, which permits unrestricted use, distribution, and reproduction in any medium, provided the original work is properly cited.

ABSTRACT: A three-dimensional model with the COMSOL Multiphysics software was used to simulate the flow behavior in straight rectangular microchannels of 500 μm width, 100 μm depth and 30mm length. The model uses the Navier-Stokes equations with no slip velocity at the wall boundary condition. The influences of structural parameters on velocity distribution, entrance length and pressure drop among microchannels were analyzed. The numerical simulations are done with a variation of hydraulic diameter, aspect ratio on a wide range of the Reynolds number (Re). The simulation results showed that geometric parameters have an effect on the velocity distribution in rectangular microchannels and it agreed well the Poiseuille laminar flow theory. Decreasing the hydraulic diameter and aspect ratio accelerate the fully development condition; in addition, the Re increase causes to postpone the flow development. For the friction factor in rectangular can be determined by the classic correlations. But, the variation of the normalized friction factor shows that the transition to turbulent flow occurs at low Reynolds.

KEYWORDS: Rectangular microchannel, Entrance length, Friction factor, Comsol Multiphysics.

1 INTRODUCTION

Microchannels, classified as the channels having a hydraulic diameter less than 1mm, are one of the essential geometry in microfluidic systems. These systems have emerged, in last few decades, an important area in research aimed at the development of microdevices. Among various microfluidic devices (microcoolers, microbiochips and microreactors...), rectangular channels are wide used for improving heat transfer and enhancing mixed efficiency and shifting fluid flow direction [1]. Therefore, the fundamental understanding of flow characteristics such as velocity distribution and pressure drop is essential in design and process control of microfluidic devices.

Seen the difficulties of experiences in this field, numerical modeling has been increasingly used to improve the study of the effects of geometrical parameters, fluid properties as well as the influence wall-fluid interactions on the pressure drop and the friction factor in mini and microchannels. Unfortunately, there are discrepancies in the different results that put the validity of the conventional fluid flow theories in discussion.

Pan and al. [2] studied the velocity distribution among parallel rectangular microchannels with length ranging from 10 to 50 mm and width and height ranging from 100 to 500 μm . The CFD results show that the width and height have a greater influence on the velocity distribution than the length.

Sang [3] used Micro Particle Velocimetry (μPIV) in order to determine the flow's hydrodynamics characteristics inside straight rectangular microchannels of 120 mm length, 260 μm height and 690 μm width. A parabolic velocity profile is found for different Reynolds number for laminar flow which agreed well the theoretical results but the entrance length is determined to be $Le = 0.033.Dh.Re$.

Lim and al. [4] used Comsol Multiphysics to study the fluid flow and heat transfer in parallel rectangular microchannels. The simulation data found after a comparison between two approaches one for single microchannel and the other for porous media, show a good agreement with theoretical results.

So, in this paper, we will investigate the effect of the different parameters on the flow characteristics especially the entrance length and the pressure drop in straight rectangular microchannel. We seek the validity of the conventional theories of the entrance length, velocity distribution and especially friction factor on the flow characteristics within the rectangular microchannels.

2 NUMERICAL METHOD AND MATHEMATICAL FORMULATION

In this study, by constructing the three-dimensional computational domain, the Commercial Code Comsol Multiphysics was used to analyze the behavior of pressure drop hydrodynamics characteristics inside rectangular microchannels. Comsol uses the finite element method in solving the governing equations to obtain distributions of pressure and velocity fields of the fluid. The steady state governing equations in vector forms are written as follows:

- **Continuity:**

$$\nabla \cdot \rho_f u = 0 \tag{1}$$

- **Momentum:**

$$\rho_f u \cdot (\nabla u) = -\nabla p + \nabla \cdot \mu_f [\nabla u + (\nabla u)^T] \tag{2}$$

Here, u is the velocity field (m/s), p is the static pressure; ρ_f and μ_f are the fluid density and viscosity, respectively.

In the flow field analysis, the following assumptions were made:

- The fluid is Newtonian
- The fluid flow is compressible and laminar
- The viscous dissipation effect, pressure work and gravity effect are neglected.
- No slip condition is applied at the walls

Under the above assumptions in the two microchannels presented in Fig.1, water was used as the working fluid with the properties taken in constant temperature (298K). Thermo-physical properties of water and silicon are summarized in Table .1.

Table 1. Thermo-physical properties of water

	Density (kg/m ³)	Viscosity (Pa.s)	Thermal conductivity	Cp (J/kg.K)
Water [5]	998.2	0.0194-1.065e-4*T+1.489e-7*T ²	-0.829+7.9 e-3*T-1.04e-2* T ²	5348-7.42*T+1.17e-2*T ²

So, the straight rectangular microchannel assumed that a uniform velocity profile was applied at the inlet. At the outlet, an atmospheric pressure was set.

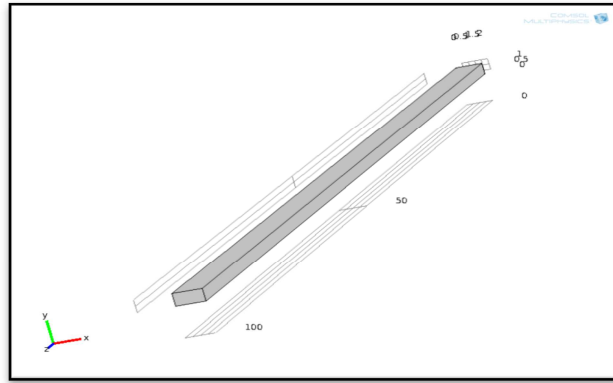

Fig. 1. 3D Rectangular geometry straight rectangular microchannels

Fig. 1 shows the rectangular microchannel used in this study. The basic dimensions used are: width=500 μm , depth=100 μm and length=30 mm. The effect of the geometrical parameters (aspect ratio, hydraulic diameter) on the flow characteristics, entrance length and pressure drop, has been studied numerically by solving the governing equations in the rectangular microchannels with different dimensions, as shown in Table.2.

Table 2. Dimensions of the channel

	Variables	Basic variables	Investigated variables
Rectangular microchannel dimensions	Wc (μm)	500	250,300,400, 500,800
	Hc (μm)	100	100,200,250,300,400,500
	Lt (mm)	30	10; 20;30

2.1 MESH

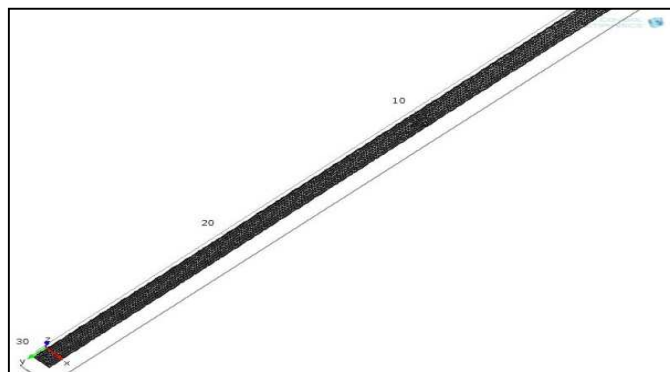

Fig. 2. The mesh grid of the rectangular channel with tetrahedral cells

The Fig.2 shows the channels after been meshed. In order to ensure the simulation accuracy, tetrahedral elements were used to generate the volume mesh. The computational grid configuration in 3D geometry was set as an instructed coarser grid seen the computer capacity.

2.2 DIMENSIONLESS NUMBER

Two dimensionless parameters often used to represent the fluid flow are the Reynolds number and the friction factor [7], [8]. The Reynolds number is defined as:

$$Re = \frac{\rho_f u_{avg} D_h}{\mu} \tag{3}$$

Where u_{avg} is the mean velocity and D_h is the hydraulic diameter. For a rectangular channel, D_h is defined as follow:

$$D_h = \frac{2 \cdot w_c \cdot h_c}{w_c + h_c} \tag{4}$$

Where w_c and h_c are respectively, the width and the height of the channel. The Darcy friction factor, for laminar flow, is calculated by the equation (5) [9]:

$$f = \frac{2 \cdot D_h \cdot \Delta p}{\rho_f \cdot L \cdot u_{avg}^2} \tag{5}$$

Where Δp is the pressure difference along the channel with length L . In order to compare numerical results of the friction factor, an equation proposed by Shah and London for fully developed, incompressible and laminar flow in straight rectangular channel was used to predict the friction factor. This equation has been proven to be adequate for liquid flows [9].

$$f_s = 96 \cdot [1 - 3,3553\alpha + 1,9457\alpha^2 - 1,7012\alpha^3 + 0,9564\alpha^4 - 0,2537\alpha^5] \tag{6}$$

Where α is the aspect ratio defined as:

$$\alpha = \frac{h_c}{w_c} \tag{7}$$

When referring to the Darcy friction factor theory, it's common to represent f as a function of Reynolds number. So, the data are also often reported as a normalized friction constant C^* vs Re given as:

$$C^* = \frac{f \cdot Re_{exp}}{f \cdot Re_{theo}} \tag{8}$$

So, the friction factor found by resolving the equation (7) will be compared by the theoretical friction factor calculated by the equation (9) as below:

$$f = \frac{64}{Re} \tag{9}$$

Δp is calculated where the flow is fully developed after the entrance length. The entrance length, defined as the distance where the maximum velocity reaches 99% times the corresponding fully developed value. So, it's crucial to determine the entrance length first. Kandlikar and al [8] has defined entrance length L_e as:

$$L_e = 0.05 \cdot D_h \cdot Re \tag{10}$$

3 RESULTS AND DISCUSSION

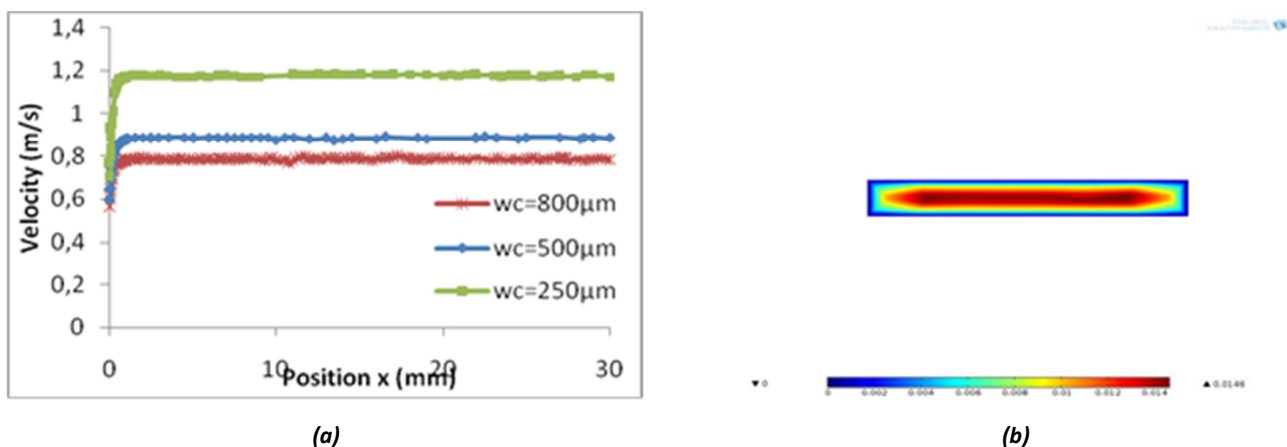

Fig. 3. Developing of the velocity profile at $Re=100$ in straight rectangular microchannel for: (a): $w_c=800\mu m$, $h_c=100\mu m$; (b):different width and $h_c=100\mu m$

Figure (3 a) shows the variation of the velocity at a centerline of a rectangular microchannel with axial position (x) at $Re=100$ for different channel's width. Fig. (3 b) shows that the water flow is developing gradually. When the fluid flows in the microchannel, velocity gradient near the wall becomes low while the maximum velocity appears at the centerline.

In order to demonstrate the validity and precision of the model assumptions and the numerical analysis, for water at $Re=140$, the variation of the water velocity at centerline of rectangular microchannel was compared with results found by Pandeya et al. (2011). The simulation was done for the same dimensions of the channel $wc=821\mu m$, $hc=215\mu m$ and the channel length is $l=44.8mm$.

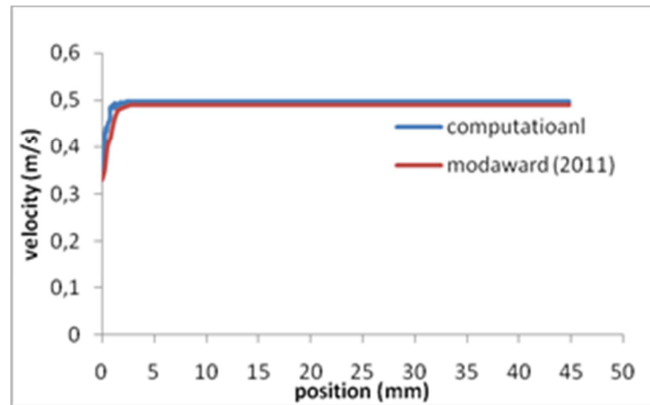

Fig. 4. comparison of the entrance length with the results found by Pandeya

As indicated in the fig 4 that the results found are approximately the same. At $Re=140$, the water flow becomes fully developed after 2.77mm. Also, the figure (3.a) shows that, at $Re=100$, the entrance length is approximately the same for different width of the channel. But, these results are a little different from the entrance length predicted by the equation (9). So, it's necessary to investigate the effect of structural parameters on the flow behavior and its development condition especially in the entrance length.

3.1 STRUCTURAL PARAMETERS EFFECT ON THE FLOW DEVELOPMENT

The effects of Reynolds number, hydraulic diameter, the aspect ratio and the total length of the microchannel on the variation of the entrance length are shown respectively in Fig.5, Fig. 6 and Fig 7.

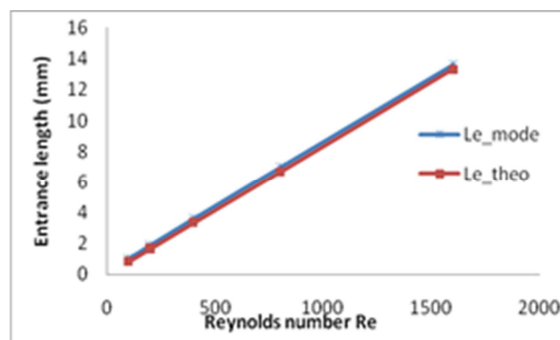

Fig. 5. Variation of the entrance length with Reynolds number for rectangular channel: $wc=500\mu m$, $hc=100\mu m$ and $L=30mm$

As it is shown in Fig.5, the entrance length variation with the Reynolds number is linear for rectangular microchannels which agreed well the theoretical results profile but the computational length is a little larger than those calculated by equation (9). An increase in Reynolds number implements the entrance length (Le), thus when the Re is high, the fluid can flow far from the inlet until it reaches the fully developed. So, at a given of microchannel, increasing the mass flow postpones the fully developed condition.

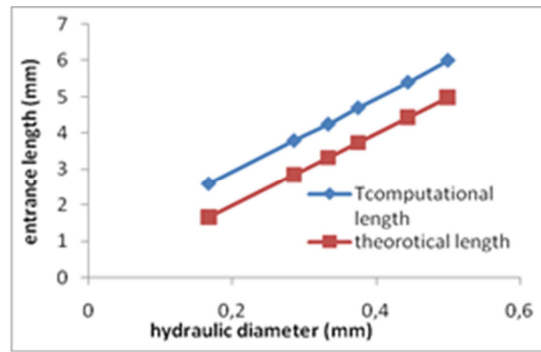

Fig. 6. Effect of the hydraulic diameter on the entrance length (Le) in rectangular microchannel

By the same way, as illustrated in Fig.6, the hydraulic diameter has an increasing effect on the entrance length for the rectangular microchannels at Reynolds number $Re= 200$.

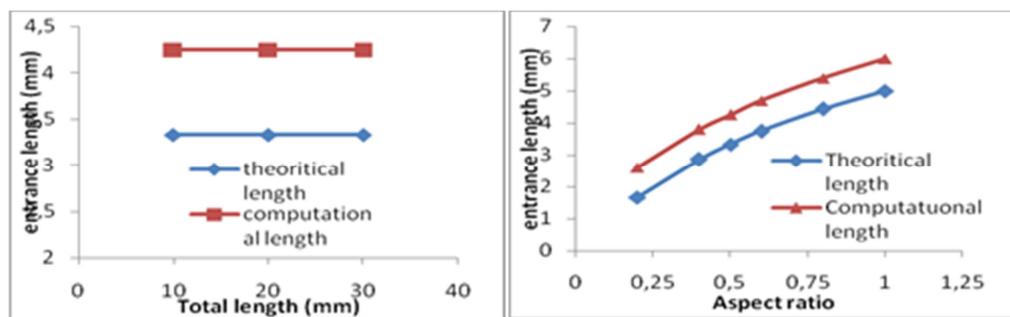

Fig. 7. variation of the entrance length with the aspect ratio and the total length for channel: $wc = 500\mu m$ and $Re=200$

Fig.7 confirms that the channel length has no effect on the development of the water flow in microchannels. The entrance length variation is linear only with the hydraulic diameter and the Reynolds number for rectangular microchannel. So, the entrance length can be calculated only with this two parameters as the correlation of Kandlikar $Le=f(D_h,Re)$.as it's shown in the figure 7, the computational entrance length has the same profile as the theoretical length calculated with equation (9); although only the computational length is larger than the calculated one. Based on the results found by the simulation, the entrance length can be written as: $Le = 0.078.D_h.Re$

3.2 EFFECTS OF THE STRUCTURAL PARAMETERS ON THE PRESSURE DISTRIBUTION

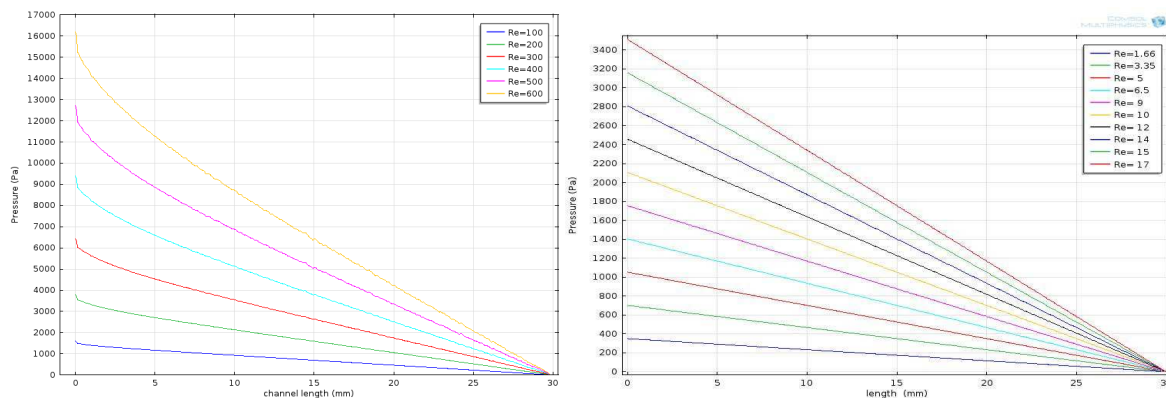

Fig. 8. Developing of the pressure profile along the channels for $wc=0.5mm$ and $wc=800\mu m$

The developing of pressure along the microchannel is shown in Fig.8, here a rectangular microchannel, (width =500 μm , depth=100 μm and channel length=30mm) was tested. At the inlet of the microchannel, the pressure profiles are not uniform and constant, but the pressure profiles become uniform and constant in streamwise direction. At a given D_h , an increase in the velocity (i.e. an increase in Re) amplifies the mean pressure along the microchannel. After passing the entrance length of microchannel, the velocity becomes fully developed. Therefore the gradient of pressure in z direction (the pressure drop) becomes linear. Increasing the Reynolds number from 100 to 600 decreases the pressure along the microchannel.

3.3 VARIATION OF FRICTION FACTOR INSIDE THE RECTANGULAR MICROCHANNELS

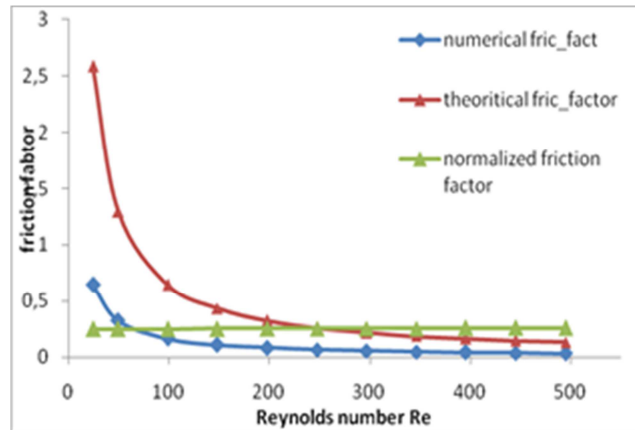

Fig. 9. Variation of the friction factor in the rectangular channel with the Reynolds number

Fig 9 shows the variation of the friction in rectangular microchannel with diemesions: $w_c=500\mu\text{m}$, $h_c=100\mu\text{m}$ and total length=30mm. we notice a difference between the friction factor found by the model with Comsol multiphysics and the theoretical friction factor. But, the both friction factors have the same profile vs the Reynolds number. So, the friction in rectangular microchannel agree the classic theories and can be calculated by the equations used in large channels.

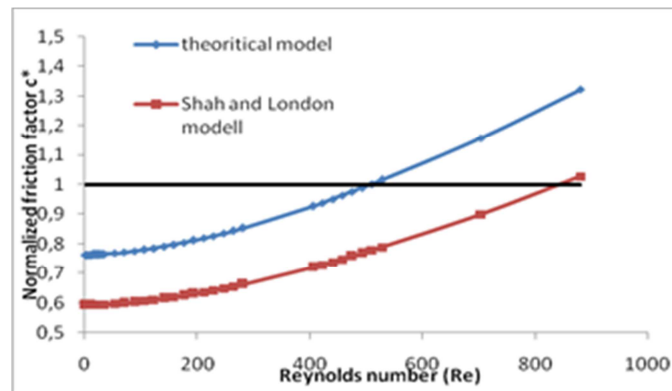

Fig. 10. Variation of normalized friction factor with Reynolds number

Because it's adequate to study the variation of the normalized fiction factor, the fig.10 shows the comparison between the normalized friction found by our model and the one calculated by eq (6). Both have the same profile of variation with the Reynolds number but the one found by the model is larger. From $Re=400$, the normalized friction is not constant. So, the transition from the laminar flow inside the rectangular begins for low Reynolds number differently from the classic theories.

4 CONCLUSION

According to the simulation results of the proposed microchannel model, the conclusions could be summarized as follows:

- The Navier-Stokes equations with the no slip velocity at the wall boundary condition are suitable to investigate the laminar fluid flow rectangular in microchannels.
- $Le = 0.05.Dh.Re$ proposed by Kandlikar is not adequate to determinate the entrance length in rectangular microchannels; it can be placed by this new correlation $Le=0.078.Dh.Re$
- Increasing the Reynolds number postpones the fully developed conditions.
- For the friction factor in rectangular can be determined by the classic correlations. But, the variation of the normalized friction factor shows that the transition to turbulent flow occurs at low Reynolds.

REFERENCES

- [1] G.P.Celata, M.Cumo, S.McPhailand G.Zummo, "Characterization of fluid dynamic behavior and channel wall effects in microtube", *International Journal Of Heat And Fluid Flow*, vol 27 (2006) 135-143.
- [2] P Minqiang, Z Dehuai, "CFD-based Study of Velocity Distribution among Multiple Parallel Microchannels", *Journal of computers*, vol. 4, no. 11, November (2009) 1133-1138.
- [3] S Y Lee, "Microchannel flow measurement using micro particle image velocimetry", *ASME International Mechanical Engineering Congress & Exposition November, 17.22, 2002, New Orleans, Louisiana*
- [4] F.Y.Lim, S.Abdullah, "Numerical study of fluid flow and heat transfer in microchannel heat sinks using anisotropic porous media approximation", *Journal of applied sciences*, 10(18) (2010) 2047-2057.
- [5] A.Pandeya, "Computational Fluid Dynamics Study of Fluid Flow and Heat Transfer in a Micro channel, *Master of Technology*, India, 2011.
- [6] J.C.CHU, J.T.Teng and R. Grief, "Experimental and numerical study on the flow characteristics in curved rectangular microchannels", *Applied Thermal Engineering*, 30 (2010), 1558-1566.
- [7] Ali Tamoyl, Majid Brahim, "Laminar flow in microchannels with a noncircular cross section", *Journal of Fluids Engineering*, Vol. 132, 2010.
- [8] S.Kandlikar, S. Garimella, D.Li, S.Colin and M R .King, 'Heat transfer and fluid flow in minichannels and microchannels', Elsevier 2006, pp 90-98.
- [9] Papautsky, T.A.Ameel and A;b;Frazier, "A review of laminar single phase flow in microchannels", *Proceedings of 2001 ASME Internatioanl Mechanical Engineering Congress and Exposition*, November 11-16, 2001, New York, NY.